

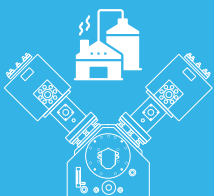

FORNOVOGAS
WE MOVE ENERGY

DA500

**RECIPROCATING COMPRESSOR
OIL FREE**

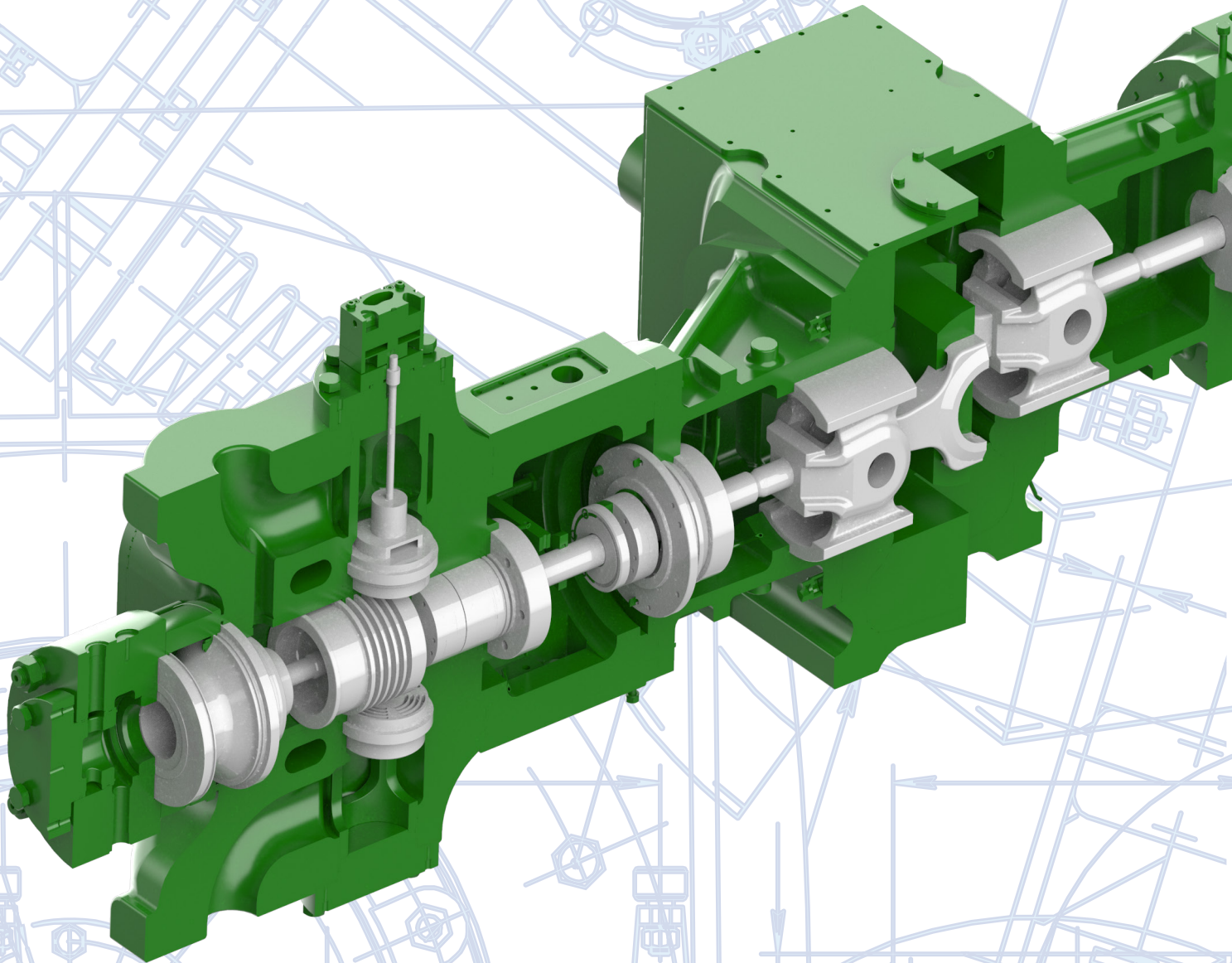

BIOGAS

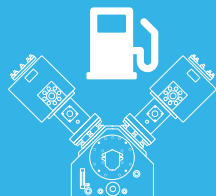

CNG

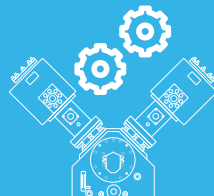

INDUSTRY

MADE IN ITALY



DA500

POWER UP TO 1200 kW

RECIPROCATING COMPRESSOR OIL FREE



MAIN FEATURES

Average speed: 500 -1800 rpm

Wide range of cylinders and bores available

Water or Air-cooling on all cylinders

Reciprocating compressor with oil free cylinders

Available in 2 or 4 cylinders configurations

Rated power:

DA 500 /2 500 kW

DA 1000 /4 1200 kW

3 strokes: 80 mm; 90 mm; 110 mm

Minimal vibrations thanks to an optimally balanced compressor

Compact layout (optimized space and ease of maintenance)

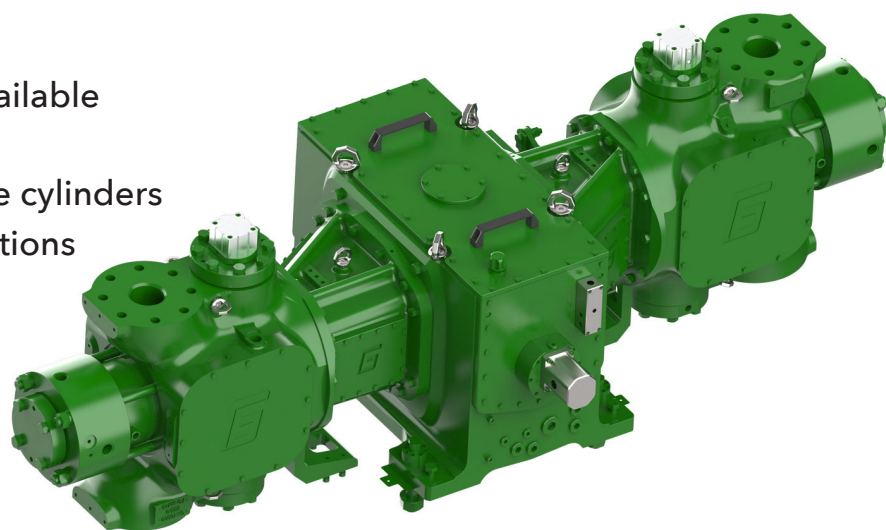

OUR SERVICE

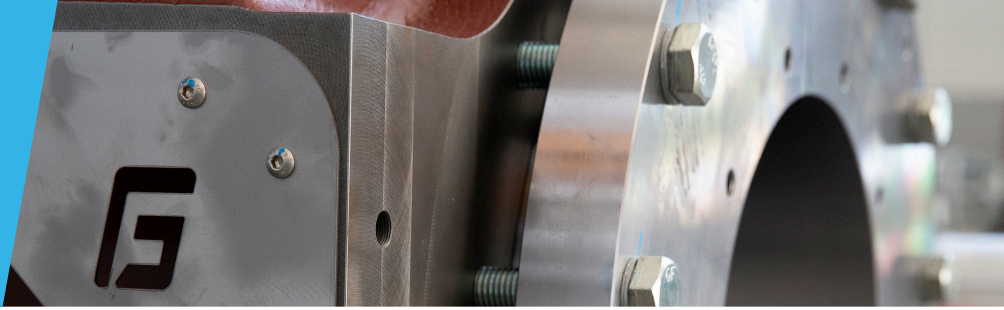

The Technical Service of Fornovo Gas in close collaboration with the Engineering Department is able to offer customers technical answers for the immediate solution of problems.

We are attentive to a strict control of the Quality of our products and to guarantee the customer a punctual, efficient and competent technical assistance.

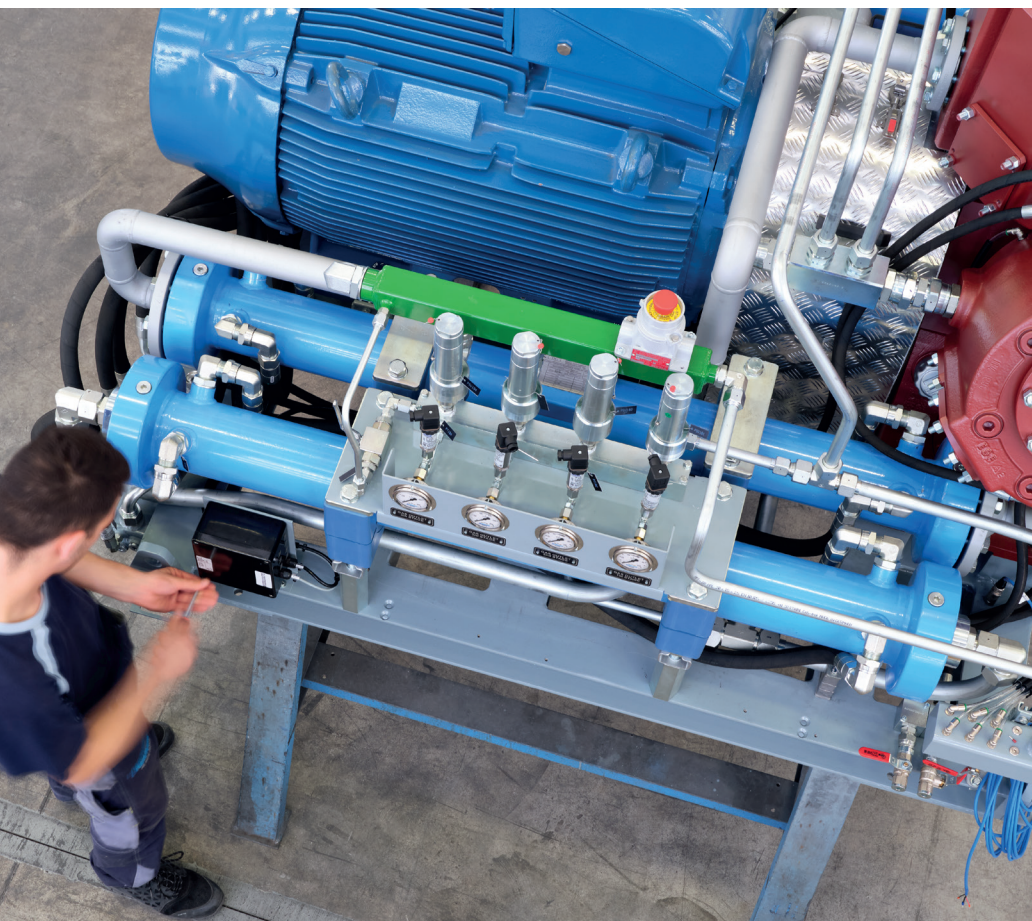
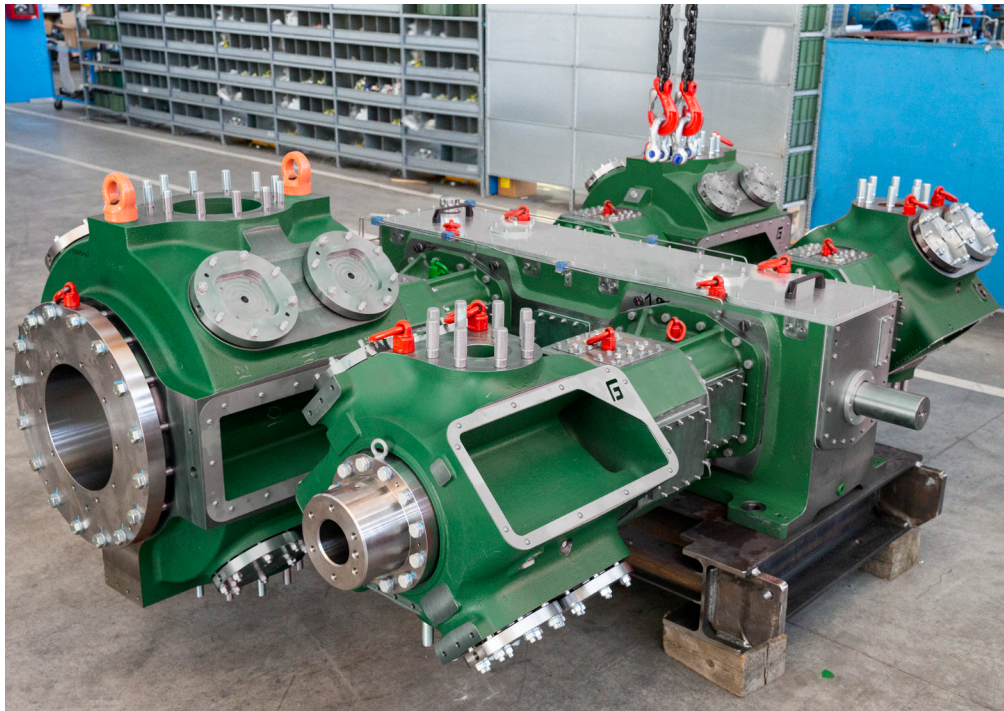

OUR ACTIVITIES

Maintaining perfect compressor efficiency has an impact on reducing the running costs of the compressors themselves during the total working cycle of the product.

This is why at Fornovo Gas we partner with our customers for:

Commissioning & start up

On-site assistance

**Predictive maintenance -
Diagnostics**

Special maintenance

Technical training

Engineering services

FORNOVOGAS
WE MOVE ENERGY

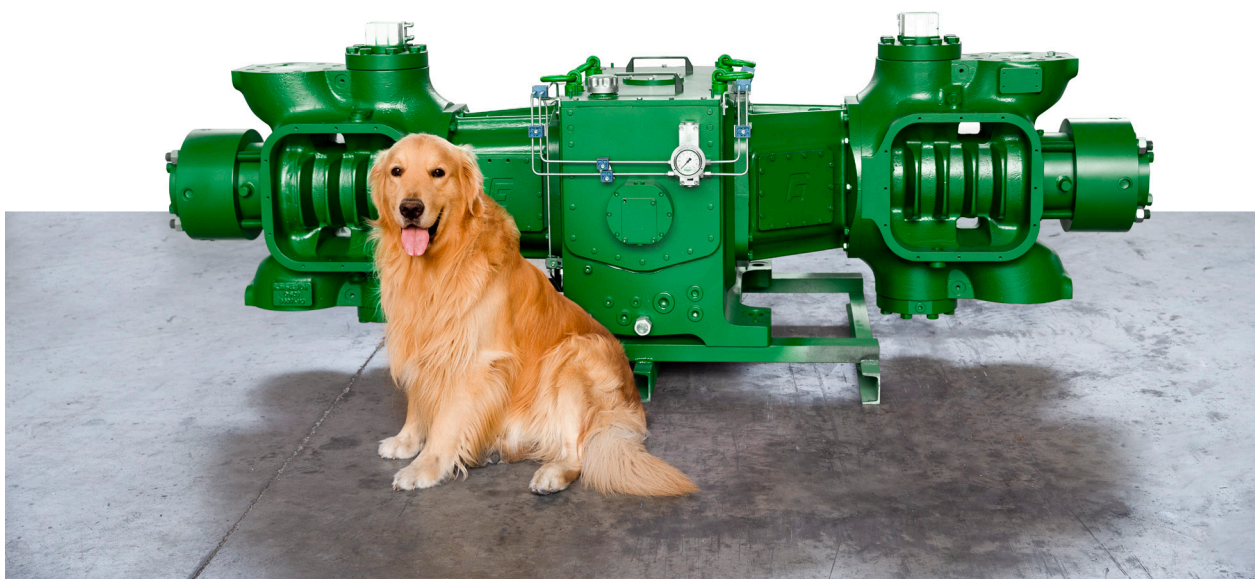

ALWAYS BY YOUR SIDE

FORNOVO GAS S.P.A.

LEGAL AND OPERATIONAL HEADQUARTERS
Via Ponticelli, 5-7 43029 Traversetolo (PR) - Italy
Tel +39 0521 1553844 Fax +39 0521 1523066
info@fornovogas.it

WWW.FORNOVOGAS.IT